

CAM LASTİKLERİ GLAZING PROFILES

Camı çerçeveye kolay ve ucuz maliyetle sabitleyerek iç mekanı dışarıdan izole eden, bir veya iki parçadan oluşan profillerdir. Ozon ve her türlü hava şartlarına mükemmel dayanım gösteren karışımlarla üretilir. İstendiğinde enjeksiyon kaynağı ile uç veya 90° birleştirme ile nihai kullanım yerine uygun ürün haline getirilir.

Malzeme

- EPDM Kauçuk, 65±5 Shore A
- Siyah





They are easy to install, locking the glass in place to give an efficient seal. Being produced with compound resisted to ozone and weathering, when desired, profiles become tailor made product by connecting each end horizontally or vertically by injection moulding.

Material

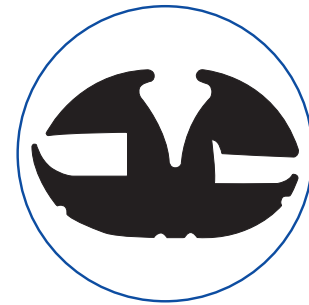
- EPDM Rubber, 65±5 Shore A
- Black

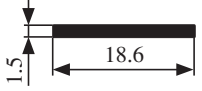

CAM LASTİKLERİ GLAZING PROFILES

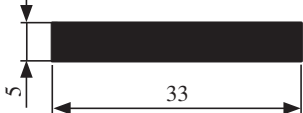
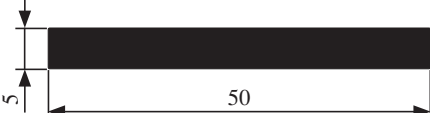
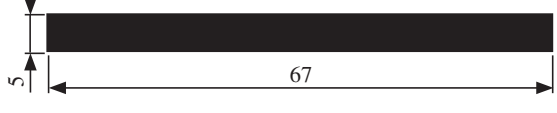
Teknik Resim Technical Drawing	Kod Reference	Eski Kodu Old Ref.	Renk Color	Malzeme Material	Ambalaj Packing (mt.)
	C1.001	M223014500	SİYAH BLACK	EPDM	100
	C1.002	M223001150	SİYAH BLACK	EPDM	100
	C1.003	M223001200	SİYAH BLACK	EPDM	50
	C1.004	M223011900	SİYAH BLACK	EPDM	50
	C1.005	M223001300	SİYAH BLACK	EPDM	25
	C1.006	M223001350	SİYAH BLACK	EPDM	25

CAM LASTİKLERİ GLAZING PROFILES

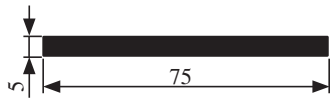
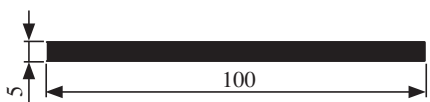
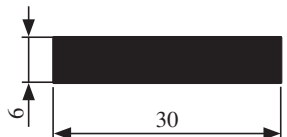
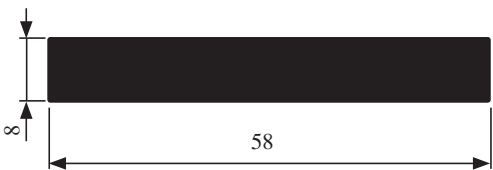
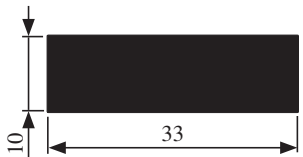
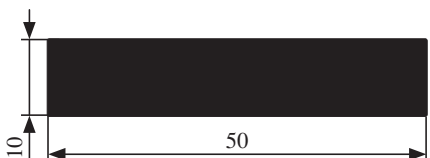
Teknik Resim Technical Drawing	Kod Reference	Eski Kodu Old Ref.	Renk Color	Malzeme Material	Ambalaj Packing (mt.)
 <p>scale:1/2</p>	C1.007	M223001400	SİYAH BLACK	EPDM	25
 <p>scale:1/2</p>	C1.008	M223001450	SİYAH BLACK	EPDM	25
	C1.009	M223012000	SİYAH BLACK	EPDM	50
	C1.010	M223001460	SİYAH BLACK	EPDM	25
	C1.011	M223000200	SİYAH BLACK	EPDM	50
	C1.012	M223016800	SİYAH BLACK	EPDM	25

CAM LASTİKLERİ GLAZING PROFILES

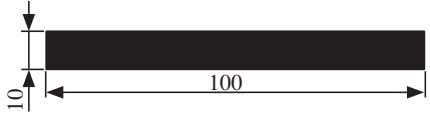
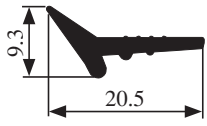
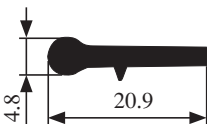
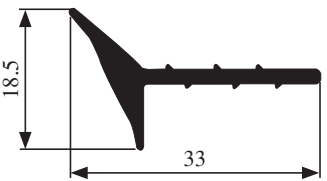
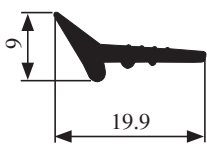
Teknik Resim Technical Drawing	Kod Reference	Eski Kodu Old Ref.	Renk Color	Malzeme Material	Ambalaj Packing (mt.)
	C1.013	M223001470	SİYAH BLACK	EPDM	25
 <p>scale:1/2</p>	C1.014	M223000100	SİYAH BLACK	EPDM	25
	C1.015	M223001700	SİYAH BLACK	EPDM	50
	C1.016	M223002300	SİYAH BLACK	EPDM	50
	C1.017	M223002400	SİYAH BLACK	EPDM	50
	C1.018	M223011700	SİYAH BLACK	EPDM	50



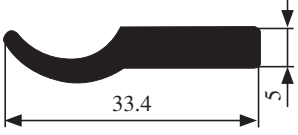
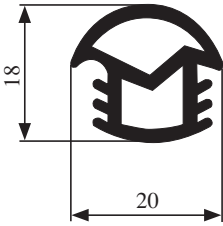
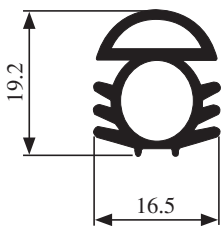
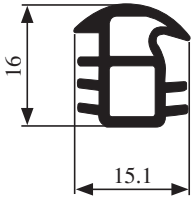
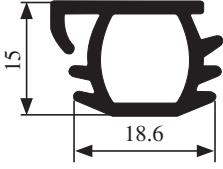
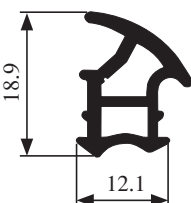

CAM LASTİKLERİ GLAZING PROFILES

Teknik Resim Technical Drawing	Kod Reference	Eski Kodu Old Ref.	Renk Color	Malzeme Material	Ambalaj Packing (mt.)
	C1.019	M223004100	SİYAH BLACK	EPDM	100
	C1.020	M223003100	SİYAH BLACK	EPDM	100
	C1.021	M223004900	SİYAH BLACK	EPDM	100
	C1.022	M223006100	SİYAH BLACK	EPDM	50
	C1.023	M223006300	SİYAH BLACK	EPDM	100
	C1.024	M223012200	SİYAH BLACK	EPDM	50

CAM LASTİKLERİ GLAZING PROFILES

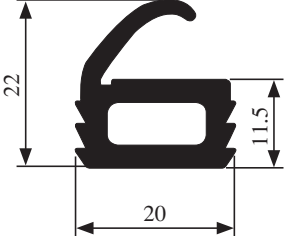
Teknik Resim Technical Drawing	Kod Reference	Eski Kodu Old Ref.	Renk Color	Malzeme Material	Ambalaj Packing (mt.)
	C1.025	M223018300	SİYAH BLACK	EPDM	50
	C1.026	M223002500	SİYAH BLACK	EPDM	50
	C1.027	M223002700	SİYAH BLACK	EPDM	50
	C1.028	M223003000	SİYAH BLACK	EPDM	50
	C1.029	M223009000	SİYAH BLACK	EPDM	50
	C1.030	M223006700	SİYAH BLACK	EPDM	50

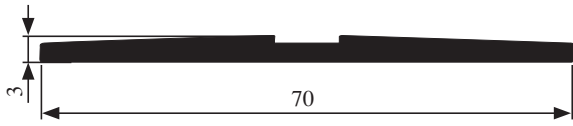
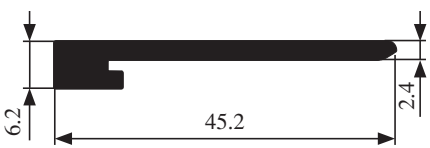
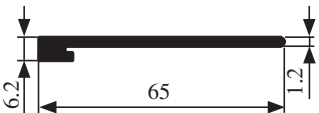
CAM LASTİKLERİ GLAZING PROFILES

Teknik Resim Technical Drawing	Kod Reference	Eski Kodu Old Ref.	Renk Color	Malzeme Material	Ambalaj Packing (mt.)
	C1.031	M223020300	SİYAH BLACK	EPDM	50
	C1.032	M223000600	SİYAH BLACK	EPDM	50
	C1.033	M223004000	SİYAH BLACK	EPDM	25
	C1.034	M223006500	SİYAH BLACK	EPDM	25
	C1.035	M223008200	SİYAH BLACK	EPDM	25
<p style="text-align: right;">scale:1/2</p> 	C1.036	M223008300	SİYAH BLACK	EPDM	50

CAM LASTİKLERİ GLAZING PROFILES

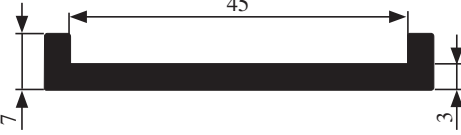
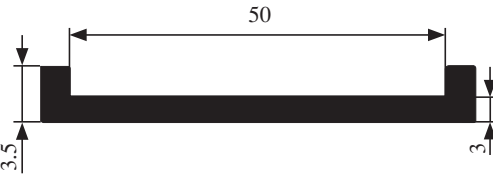
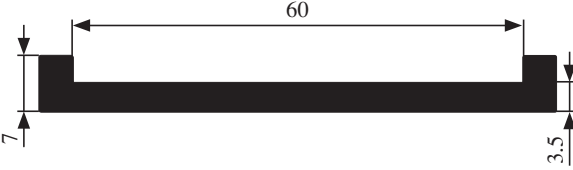
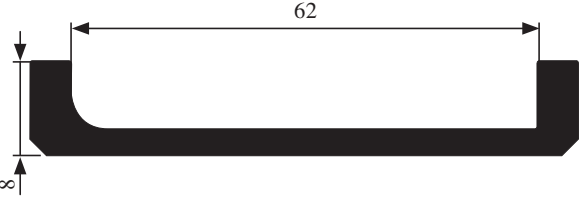
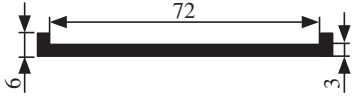
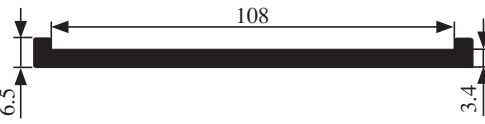
Teknik Resim Technical Drawing	Kod Reference	Eski Kodu Old Ref.	Renk Color	Malzeme Material	Ambalaj Packing (mt.)
	C1.037	M223010900	SİYAH BLACK	EPDM	25
	C1.038	M223011400	SİYAH BLACK	EPDM	25
	C1.039	M223011100	SİYAH BLACK	EPDM	25
	C1.040	M223018200	SİYAH BLACK	EPDM	25
 <p style="text-align: right;">scale:1/2</p>	C1.041	M223018500	SİYAH BLACK	EPDM	25
 <p style="text-align: right;">scale:1/2</p>	C1.042	M223010700	SİYAH BLACK	EPDM	25

CAM LASTİKLERİ GLAZING PROFILES

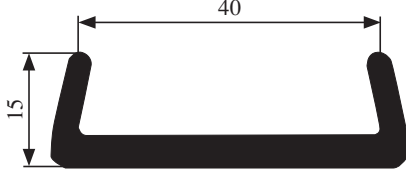
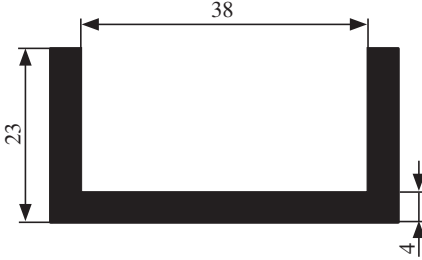
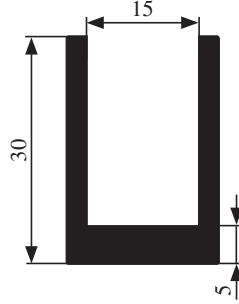
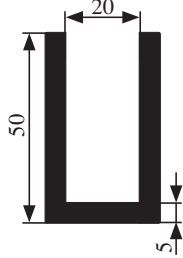
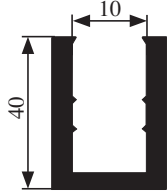
Teknik Resim Technical Drawing	Kod Reference	Eski Kodu Old Ref.	Renk Color	Malzeme Material	Ambalaj Packing (mt.)
 <p>scale:1/3</p>	C1.043	M223010800	SİYAH BLACK	EPDM	25
	C1.044	M223003600	SİYAH BLACK	EPDM	25
	C1.045	M223000500	SİYAH BLACK	EPDM	25
	C1.046	M223017800	SİYAH BLACK	EPDM	25
 <p>scale:1/2</p>	C1.047	M223014200	SİYAH BLACK	EPDM	25
 <p>scale:1/2</p>	C1.048	M223004400	SİYAH BLACK	EPDM	25

CAM LASTİKLERİ GLAZING PROFILES

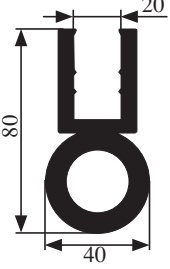
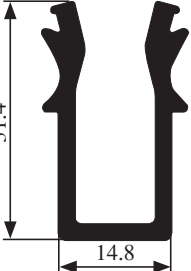
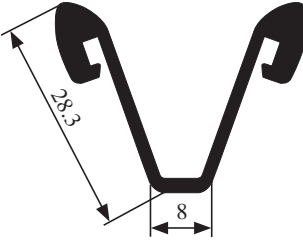
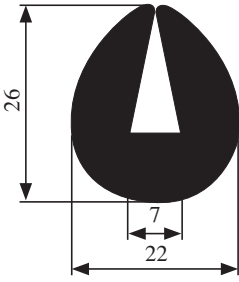
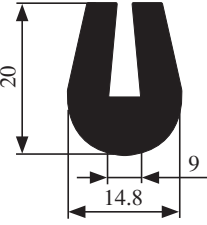
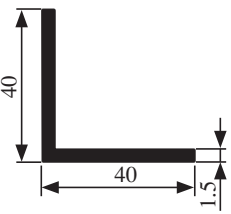
Teknik Resim Technical Drawing	Kod Reference	Eski Kodu Old Ref.	Renk Color	Malzeme Material	Ambalaj Packing (mt.)
 <p>scale:1/3</p>	C1.049	M223003500	SİYAH BLACK	EPDM	25
	C1.050	M223011200	SİYAH BLACK	EPDM	25
	C1.051	M223011500	SİYAH BLACK	EPDM	25
	C1.052	M223013200	SİYAH BLACK	EPDM	25
	C1.053	M223013300	SİYAH BLACK	EPDM	50
 <p>scale:1/2</p>	C1.054	M223006400	SİYAH BLACK	EPDM	25

CAM LASTİKLERİ GLAZING PROFILES

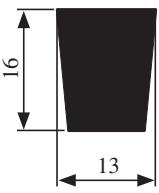
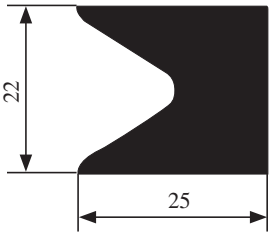
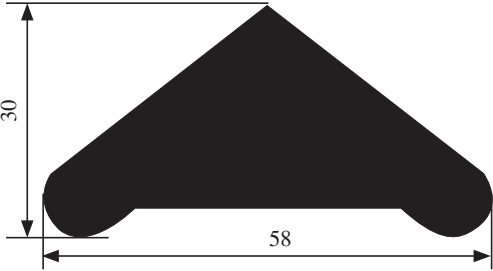
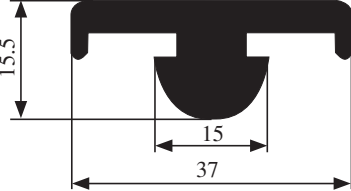
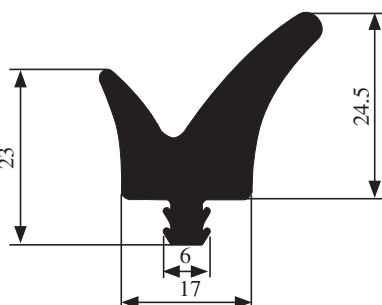
Teknik Resim Technical Drawing	Kod Reference	Eski Kodu Old Ref.	Renk Color	Malzeme Material	Ambalaj Packing (mt.)
 <p>scale:1/2</p>	C1.055	M223003900	SİYAH BLACK	EPDM	25
	C1.056	M223000300	SİYAH BLACK	EPDM	50
	C1.057	M223000400	SİYAH BLACK	EPDM	50
	C1.058	M223000800	SİYAH BLACK	EPDM	25
	C1.059	M223003700	SİYAH BLACK	EPDM	25
	C1.060	M223003800	SİYAH BLACK	EPDM	25

CAM LASTİKLERİ GLAZING PROFILES

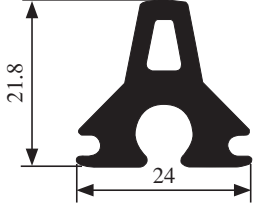
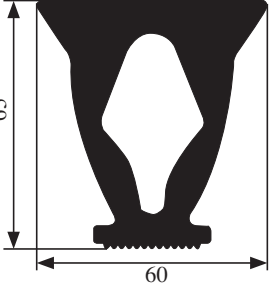
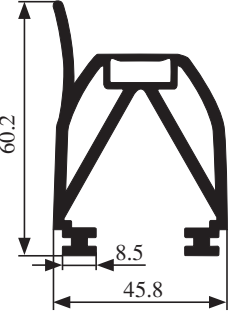
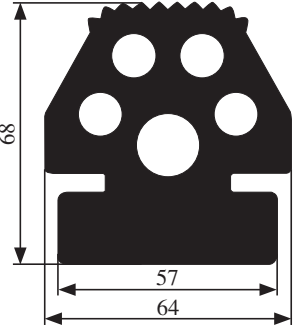
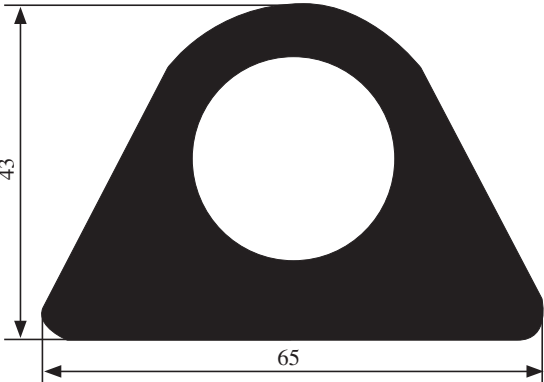
Teknik Resim Technical Drawing	Kod Reference	Eski Kodu Old Ref.	Renk Color	Malzeme Material	Ambalaj Packing (mt.)
	C1.061	M223004300	SİYAH BLACK	EPDM	50
 <p>scale:1/2</p>	C1.062	M223001600	SİYAH BLACK	EPDM	25
 <p>scale:1/2</p>	C1.063	M223001800	SİYAH BLACK	EPDM	25
 <p>scale:1/2</p>	C1.064	M223004200	SİYAH BLACK	EPDM	20
	C1.065	M223006000	SİYAH BLACK	EPDM	20

CAM LASTİKLERİ GLAZING PROFILES

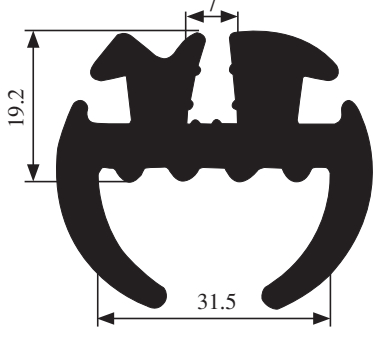
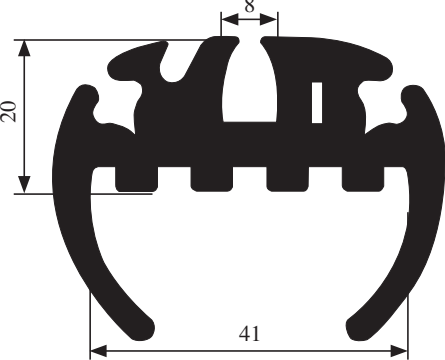
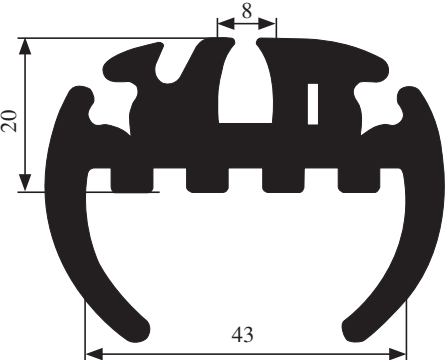
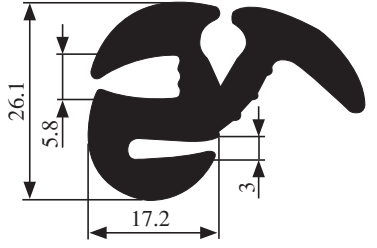
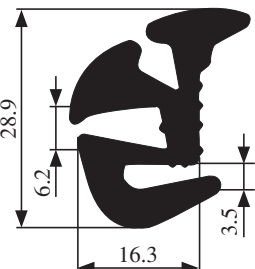
Teknik Resim Technical Drawing	Kod Reference	Eski Kodu Old Ref.	Renk Color	Malzeme Material	Ambalaj Packing (mt.)
 <p>Technical drawing of cam profile C1.066. Dimensions: 19.2 (height), 7 (width of top notch), 31.5 (width of base).</p>	C1.066	M223000700	SİYAH BLACK	EPDM	25
 <p>Technical drawing of cam profile C1.067. Dimensions: 20 (height), 8 (width of top notch), 41 (width of base).</p>	C1.067	M223001000	SİYAH BLACK	EPDM	25
 <p>Technical drawing of cam profile C1.068. Dimensions: 20 (height), 8 (width of top notch), 43 (width of base).</p>	C1.068	M223001100	SİYAH BLACK	EPDM	25
 <p>Technical drawing of cam profile C1.069. Dimensions: 26.1 (height), 5.8 (width of top notch), 17.2 (width of base), 3 (width of bottom notch).</p>	C1.069	M223001500	SİYAH BLACK	EPDM	50
 <p>Technical drawing of cam profile C1.070. Dimensions: 28.9 (height), 6.2 (width of top notch), 16.3 (width of base), 3.5 (width of bottom notch).</p>	C1.070	M223007600	SİYAH BLACK	EPDM	50

CAM LASTİKLERİ GLAZING PROFILES

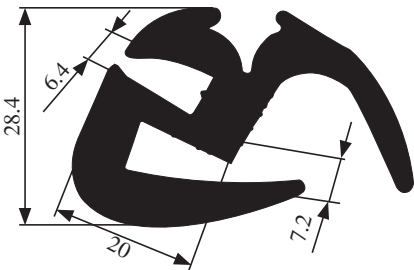
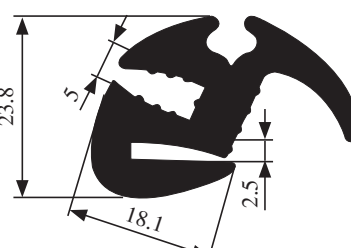
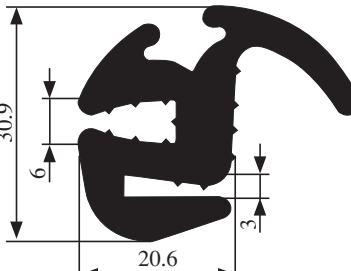
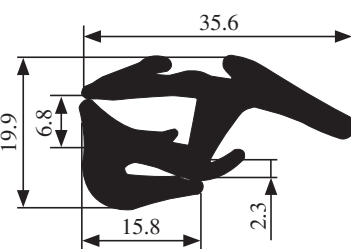
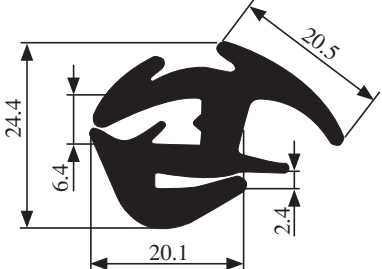
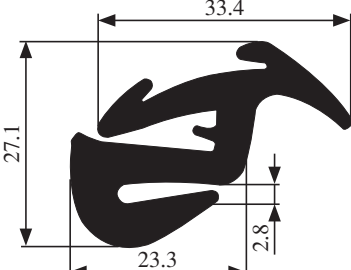
Teknik Resim Technical Drawing	Kod Reference	Eski Kodu Old Ref.	Renk Color	Malzeme Material	Ambalaj Packing (mt.)
	C1.071	M223007700	SİYAH BLACK	EPDM	50
	C1.072	M223007800	SİYAH BLACK	EPDM	50
	C1.073	M223009100	SİYAH BLACK	EPDM	50
	C1.074	M223014300	SİYAH BLACK	EPDM	50
	C1.075	M223018600	SİYAH BLACK	EPDM	50
	C1.076	M223015200	SİYAH BLACK	EPDM	50



CAM LASTİKLERİ GLAZING PROFILES

Teknik Resim Technical Drawing	Kod Reference	Eski Kodu Old Ref.	Renk Color	Malzeme Material	Ambalaj Packing (mt.)
	C1.077	M223016200	SİYAH BLACK	EPDM	50
	C1.078	M223016300	SİYAH BLACK	EPDM	50
	C1.079	M223016400	SİYAH BLACK	EPDM	50
	C1.080	M223017700	SİYAH BLACK	EPDM	50
	C1.081	M223005300	SİYAH BLACK	EPDM	50
	C1.082	M223013000	SİYAH BLACK	EPDM	50

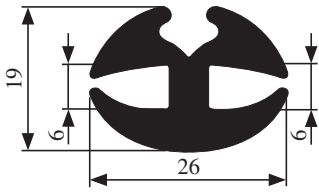
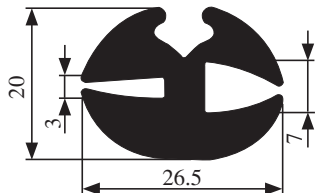
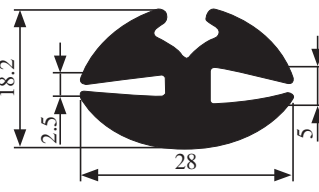
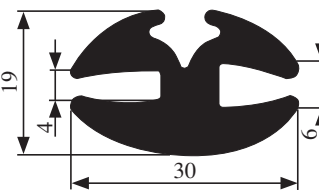
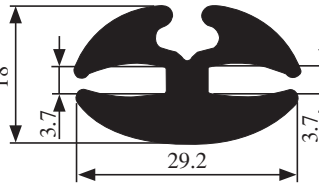
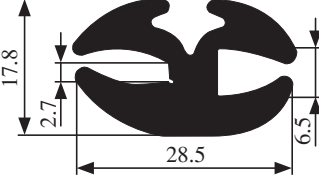
CAM LASTİKLERİ GLAZING PROFILES

Teknik Resim Technical Drawing	Kod Reference	Eski Kodu Old Ref.	Renk Color	Malzeme Material	Ambalaj Packing (mt.)
	C1.083	M223013100	SİYAH BLACK	EPDM	50
	C1.084	M223005200	SİYAH BLACK	EPDM	50
	C1.085	M223003200	SİYAH BLACK	EPDM	50
	C1.086	M223001900	SİYAH BLACK	EPDM	50
	C1.087	M223011300	SİYAH BLACK	EPDM	50
	C1.088	M223006600	SİYAH BLACK	EPDM	50

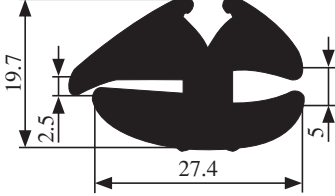
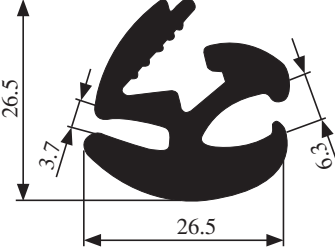
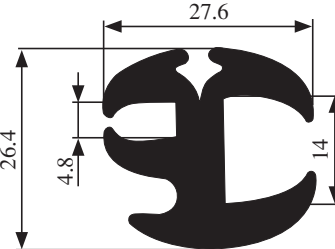
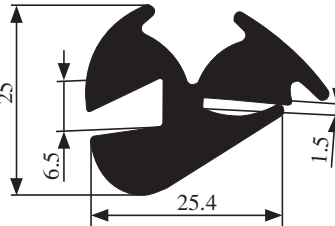
CAM LASTİKLERİ GLAZING PROFILES

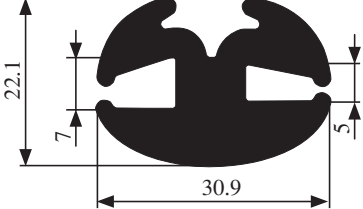
Teknik Resim Technical Drawing	Kod Reference	Eski Kodu Old Ref.	Renk Color	Malzeme Material	Ambalaj Packing (mt.)
	C1.089	M223017000	SİYAH BLACK	EPDM	50
	C1.090	M223005400	SİYAH BLACK	EPDM	50
	C1.091	M223002100	SİYAH BLACK	EPDM	50
	C1.092	M223005700	SİYAH BLACK	EPDM	50
	C1.093	M223005800	SİYAH BLACK	EPDM	50
	C1.094	M223014400	SİYAH BLACK	EPDM	50

CAM LASTİKLERİ GLAZING PROFILES

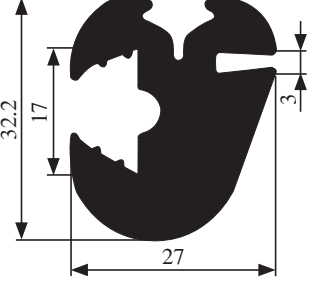
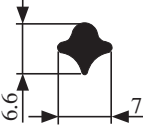
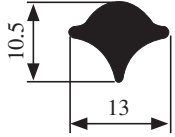
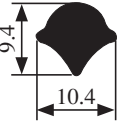
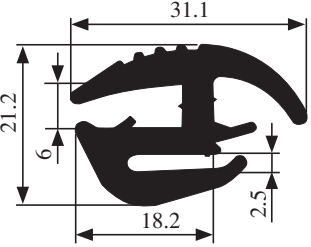
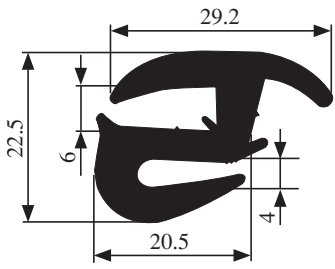
Teknik Resim Technical Drawing	Kod Reference	Eski Kodu Old Ref.	Renk Color	Malzeme Material	Ambalaj Packing (mt.)
	C1.095	M223018000	SİYAH BLACK	EPDM	50
	C1.096	M223003300	SİYAH BLACK	EPDM	100
	C1.097	M223005900	SİYAH BLACK	EPDM	100
	C1.098	M223019900	SİYAH BLACK	EPDM	100
	C1.099	M223002000	SİYAH BLACK	EPDM	50
	C1.100	M223002200	SİYAH BLACK	EPDM	50

CAM LASTİKLERİ GLAZING PROFILES

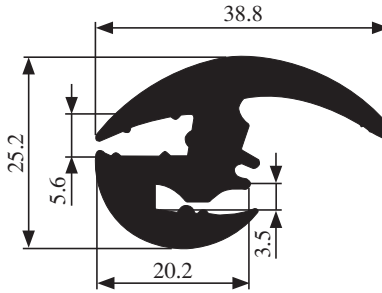
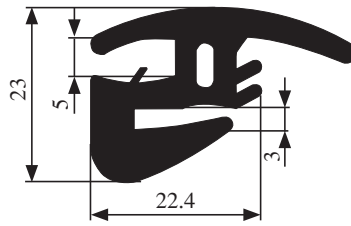
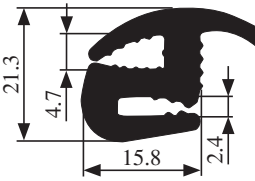
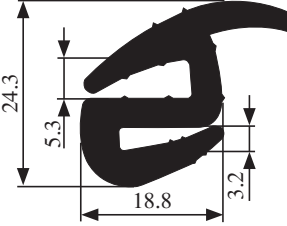
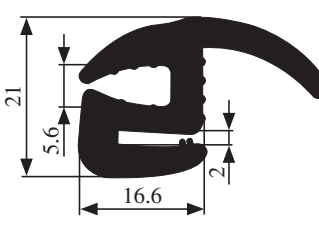
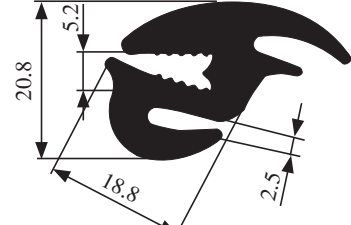
Teknik Resim Technical Drawing	Kod Reference	Eski Kodu Old Ref.	Renk Color	Malzeme Material	Ambalaj Packing (mt.)
	C1.101	M223004800	SİYAH BLACK	EPDM	50
	C1.102	M223006200	SİYAH BLACK	EPDM	50
	C1.104	M223007300	SİYAH BLACK	EPDM	50
	C1.105	M223007400	SİYAH BLACK	EPDM	50
	C1.106	M223007500	SİYAH BLACK	EPDM	50
	C1.107	M223007900	SİYAH BLACK	EPDM	50

CAM LASTİKLERİ GLAZING PROFILES

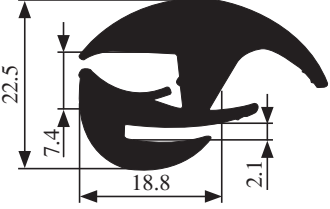
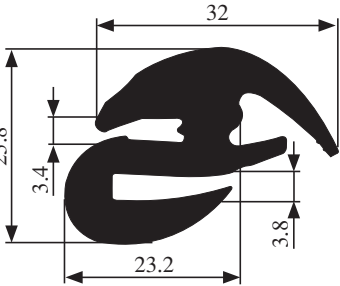
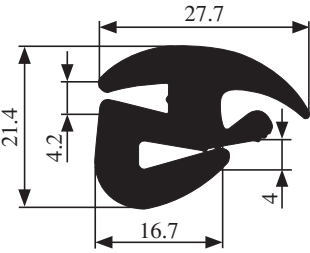
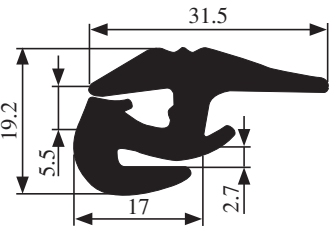
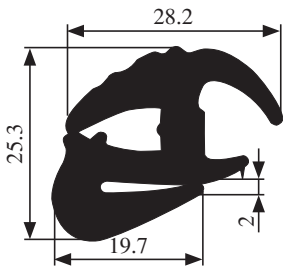
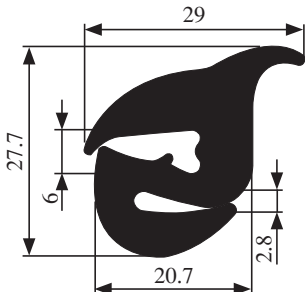
Teknik Resim Technical Drawing	Kod Reference	Eski Kodu Old Ref.	Renk Color	Malzeme Material	Ambalaj Packing (mt.)
	C1.108	M223008000	SİYAH BLACK	EPDM	50
	C1.109	M223008400	SİYAH BLACK	EPDM	50
	C1.110	M223012300	SİYAH BLACK	EPDM	50
	C1.111	M223012400	SİYAH BLACK	EPDM	50
	C1.112	M223016100	SİYAH BLACK	EPDM	50
	C1.113	M223013400	SİYAH BLACK	EPDM	50

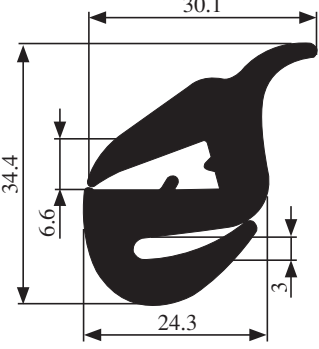
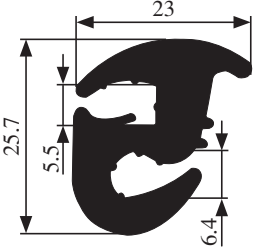
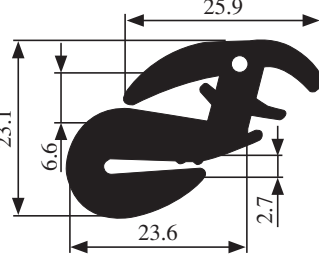
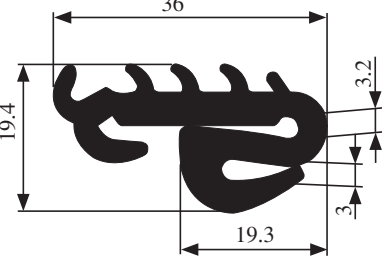
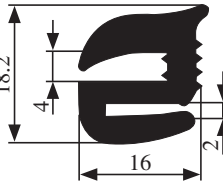
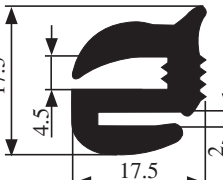

CAM LASTİKLERİ GLAZING PROFILES

Teknik Resim Technical Drawing	Kod Reference	Eski Kodu Old Ref.	Renk Color	Malzeme Material	Ambalaj Packing (mt.)
	C1.114	M223013600	SİYAH BLACK	EPDM	50
	C1.115	M223017200	SİYAH BLACK	EPDM	50
	C1.116	M223017900	SİYAH BLACK	EPDM	50
	C1.117	M223013500	SİYAH BLACK	EPDM	50
	C1.118	M223005500	SİYAH BLACK	EPDM	50
	C1.119	M223005600	SİYAH BLACK	EPDM	50

CAM LASTİKLERİ GLAZING PROFILES

Teknik Resim Technical Drawing	Kod Reference	Eski Kodu Old Ref.	Renk Color	Malzeme Material	Ambalaj Packing (mt.)
	C1.120	M223011800	SİYAH BLACK	EPDM	50
	C1.121	M223002800	SİYAH BLACK	EPDM	50
	C1.122	M223002950	SİYAH BLACK	EPDM	50
	C1.123	M223016700	SİYAH BLACK	EPDM	50
	C1.124	M223002900	SİYAH BLACK	EPDM	50
	C1.125	M223020500	SİYAH BLACK	EPDM	50

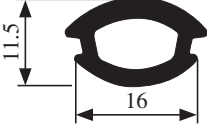
CAM LASTİKLERİ GLAZING PROFILES

Teknik Resim Technical Drawing	Kod Reference	Eski Kodu Old Ref.	Renk Color	Malzeme Material	Ambalaj Packing (mt.)
	C1.126	M223003400	SİYAH BLACK	EPDM	50
	C1.127	M223008500	SİYAH BLACK	EPDM	50
	C1.128	M223008600	SİYAH BLACK	EPDM	50
	C1.129	M223003500	SİYAH BLACK	EPDM	50
	C1.130	M223019500	SİYAH BLACK	EPDM	50
	C1.131	M223004600	SİYAH BLACK	EPDM	50

CAM LASTİKLERİ GLAZING PROFILES

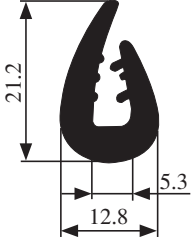
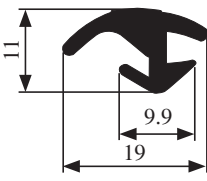
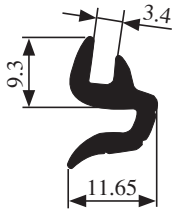
Teknik Resim Technical Drawing	Kod Reference	Eski Kodu Old Ref.	Renk Color	Malzeme Material	Ambalaj Packing (mt.)
	C1.132	M223013800	SİYAH BLACK	EPDM	50
	C1.133	M223004700	SİYAH BLACK	EPDM	50
	C1.134	M223005000	SİYAH BLACK	EPDM	50
	C1.135	M223005100	SİYAH BLACK	EPDM	50
	C1.136	M223006800	SİYAH BLACK	EPDM	50
	C1.137	M223006900	SİYAH BLACK	EPDM	50

CAM LASTİKLERİ GLAZING PROFILES

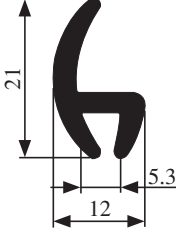
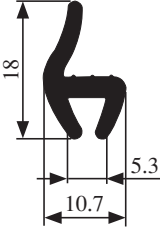
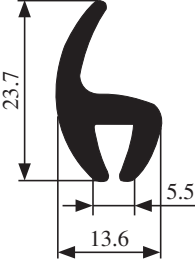
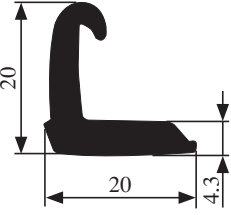
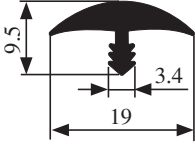
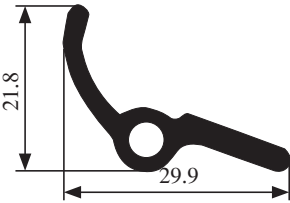
Teknik Resim Technical Drawing	Kod Reference	Eski Kodu Old Ref.	Renk Color	Malzeme Material	Ambalaj Packing (mt.)
	C1.138	M223007000	SİYAH BLACK	EPDM	50
	C1.139	M223011600	SİYAH BLACK	EPDM	50
	C1.140	M223014000	SİYAH BLACK	EPDM	50
	C1.141	M223007100	SİYAH BLACK	EPDM	50
	C1.142	M223008100	SİYAH BLACK	EPDM	50
	C1.143	M223009200	SİYAH BLACK	EPDM	50

CAM LASTİKLERİ GLAZING PROFILES

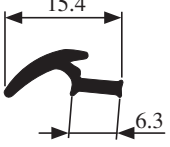
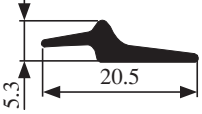
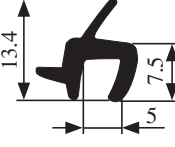
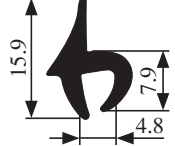
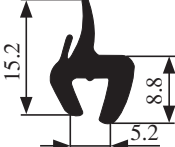
Teknik Resim Technical Drawing	Kod Reference	Eski Kodu Old Ref.	Renk Color	Malzeme Material	Ambalaj Packing (mt.)
	C1.144	M223012100	SİYAH BLACK	EPDM	50
	C1.145	M223013700	SİYAH BLACK	EPDM	100
	C1.146	M223014600	SİYAH BLACK	EPDM	100
	C1.147	M223017400	SİYAH BLACK	EPDM	100
	C1.148	M223017600	SİYAH BLACK	EPDM	100
	C1.149	M223017500	SİYAH BLACK	EPDM	100

CAM LASTİKLERİ GLAZING PROFILES

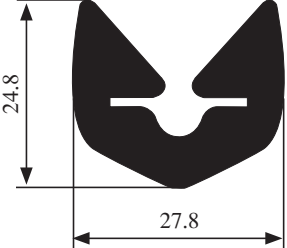
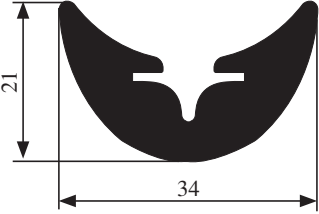
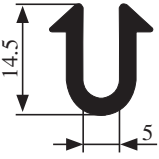
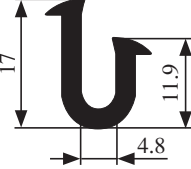
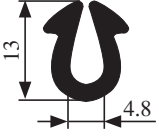
Teknik Resim Technical Drawing	Kod Reference	Eski Kodu Old Ref.	Renk Color	Malzeme Material	Ambalaj Packing (mt.)
	C1.150	M223008700	SİYAH BLACK	EPDM	50
	C1.151	M223008800	SİYAH BLACK	EPDM	50
	C1.152	M223008900	SİYAH BLACK	EPDM	50
	C1.153	M223009300	SİYAH BLACK	EPDM	50
	C1.154	M223009400	SİYAH BLACK	EPDM	50
	C1.155	M223009500	SİYAH BLACK	EPDM	50

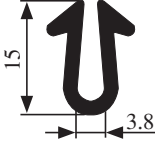
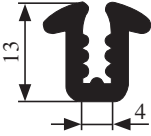
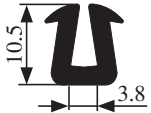
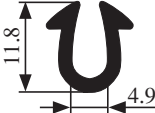

CAM LASTİKLERİ GLAZING PROFILES

Teknik Resim Technical Drawing	Kod Reference	Eski Kodu Old Ref.	Renk Color	Malzeme Material	Ambalaj Packing (mt.)
	C1.156	M223016600	SİYAH BLACK	EPDM	50
	C1.157	M223010300	SİYAH BLACK	EPDM	50
	C1.158	M223010200	SİYAH BLACK	EPDM	50
	C1.159	M223010400	SİYAH BLACK	EPDM	50
	C1.160	M223010500	SİYAH BLACK	EPDM	50
	C1.161	M223019300	SİYAH BLACK	EPDM	50

CAM LASTİKLERİ GLAZING PROFILES

Teknik Resim Technical Drawing	Kod Reference	Eski Kodu Old Ref.	Renk Color	Malzeme Material	Ambalaj Packing (mt.)
	C1.162	M223020200	SİYAH BLACK	EPDM	50
	C1.163	M223019000	SİYAH BLACK	EPDM	50
	C1.164	M223019200	SİYAH BLACK	EPDM	50
	C1.165	M223009900	SİYAH BLACK	EPDM	50
	C1.166	M223009600	SİYAH BLACK	EPDM	50
	C1.167	M223009700	SİYAH BLACK	EPDM	50

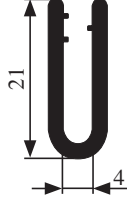
CAM LASTİKLERİ GLAZING PROFILES

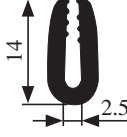
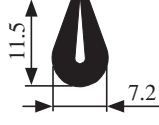
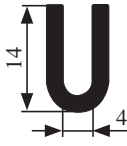
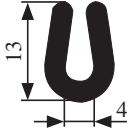
Teknik Resim Technical Drawing	Kod Reference	Eski Kodu Old Ref.	Renk Color	Malzeme Material	Ambalaj Packing (mt.)
	C1.168	M223009800	SİYAH BLACK	EPDM	50
	C1.169	M223015700	SİYAH BLACK	EPDM	50
	C1.170	M223010000	SİYAH BLACK	EPDM	50
	C1.171	M223014100	SİYAH BLACK	EPDM	50
	C1.172	M223010100	SİYAH BLACK	EPDM	50
	C1.173	M223010600	SİYAH BLACK	EPDM	50

CAM LASTİKLERİ GLAZING PROFILES

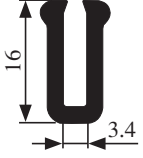
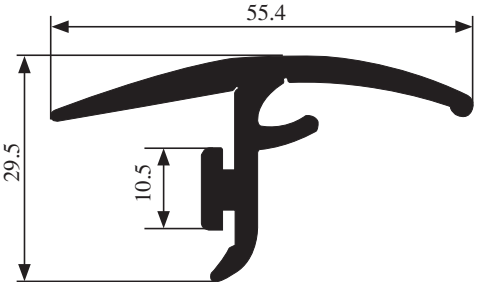
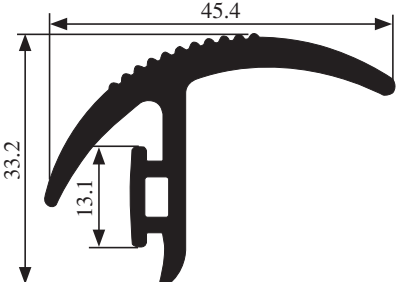
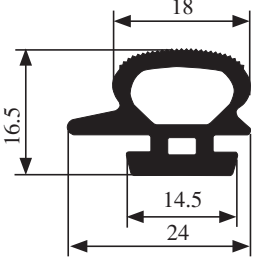
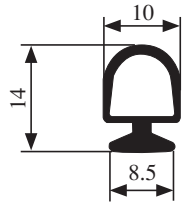
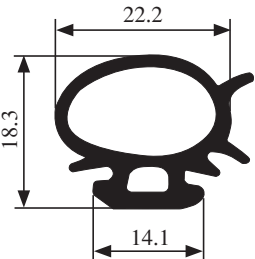
Teknik Resim Technical Drawing	Kod Reference	Eski Kodu Old Ref.	Renk Color	Malzeme Material	Ambalaj Packing (mt.)
	C1.174	M223011100	SİYAH BLACK	EPDM	50
	C1.175	M223012500	SİYAH BLACK	EPDM	30
	C1.176	M223012760	SİYAH BLACK	EPDM	30
	C1.177	M223012600	SİYAH BLACK	EPDM	50
	C1.178	M223012700	SİYAH BLACK	EPDM	100
	C1.179	M223012750	SİYAH BLACK	EPDM	50

CAM LASTİKLERİ GLAZING PROFILES

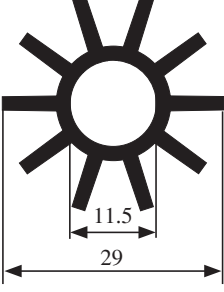
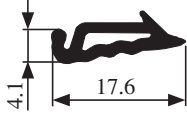
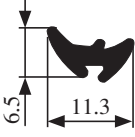
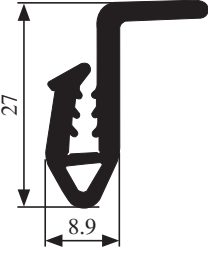
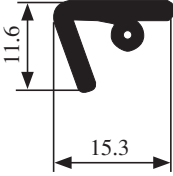
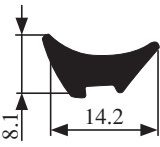
Teknik Resim Technical Drawing	Kod Reference	Eski Kodu Old Ref.	Renk Color	Malzeme Material	Ambalaj Packing (mt.)
	C1.180	M223013900	SİYAH BLACK	EPDM	50
	C1.181	M223014700	SİYAH BLACK	EPDM	50
	C1.182	M223014800	SİYAH BLACK	EPDM	50
	C1.183	M223014900	SİYAH BLACK	EPDM	50
	C1.184	M223015000	SİYAH BLACK	EPDM	50
	C1.185	M223015100	SİYAH BLACK	EPDM	50

CAM LASTİKLERİ GLAZING PROFILES

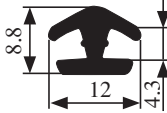
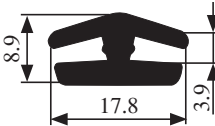
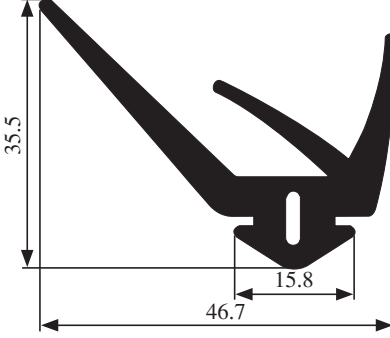
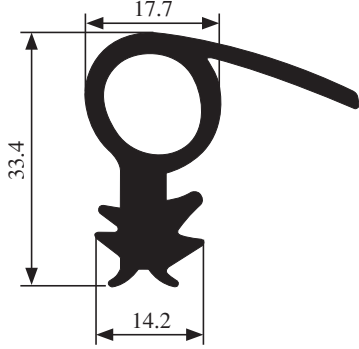
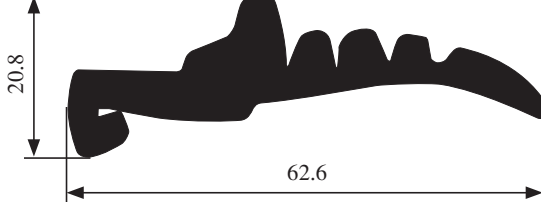
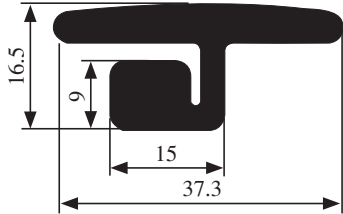
Teknik Resim Technical Drawing	Kod Reference	Eski Kodu Old Ref.	Renk Color	Malzeme Material	Ambalaj Packing (mt.)
	C1.186	M223016500	SİYAH BLACK	EPDM	50
	C1.187	M223016900	SİYAH BLACK	EPDM	50
	C1.188	M223017100	SİYAH BLACK	EPDM	30
	C1.189	M223017300	SİYAH BLACK	EPDM	30
	C1.190	M223015800	SİYAH BLACK	EPDM	30
	C1.191	M223018701	SİYAH BLACK	EPDM	30

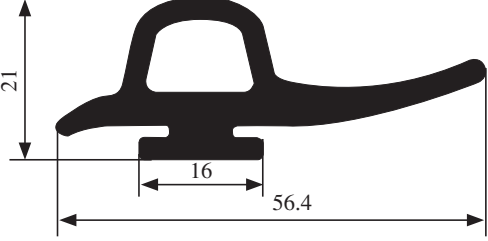
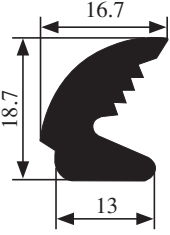
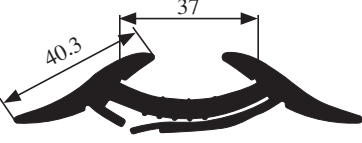
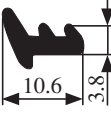
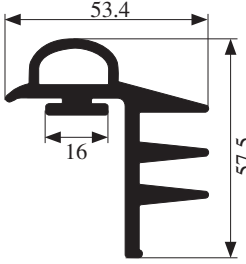
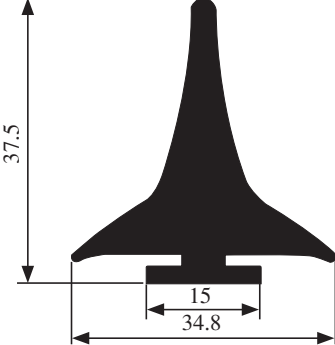

CAM LASTİKLERİ GLAZING PROFILES

Teknik Resim Technical Drawing	Kod Reference	Eski Kodu Old Ref.	Renk Color	Malzeme Material	Ambalaj Packing (mt.)
	C1.192	M223018800	SİYAH BLACK	EPDM	25
	C1.193	M223019100	SİYAH BLACK	EPDM	50
 <p>scale:1/2</p>	C1.194	M223019800	SİYAH BLACK	EPDM	25
	C1.195	M223019400	SİYAH BLACK	EPDM	100
 <p>scale:1/2</p>	C1.196	M223020100	SİYAH BLACK	EPDM	5
	C1.197	M223020000	SİYAH BLACK	EPDM	30

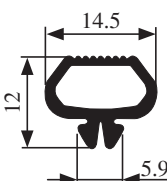
CAM LASTİKLERİ GLAZING PROFILES

Teknik Resim Technical Drawing	Kod Reference	Eski Kodu Old Ref.	Renk Color	Malzeme Material	Ambalaj Packing (mt.)
	C1.198	M223020401	SİYAH BLACK	EPDM	50
	C1.199	-	SİYAH BLACK	EPDM	50
	C1.202	M223012770	SİYAH BLACK	EPDM	50
	C1.203	M223019600	SİYAH BLACK	EPDM	50
	C1.204	M223019700	SİYAH BLACK	EPDM	100
	C1.205	-	SİYAH BLACK	EPDM	100

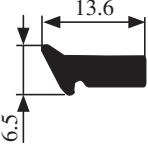
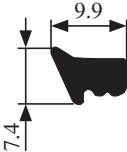
CAM LASTİKLERİ GLAZING PROFILES

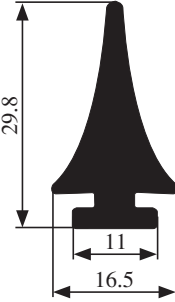
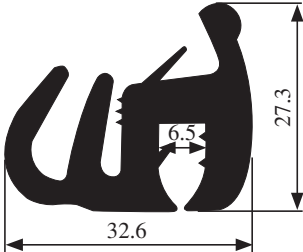
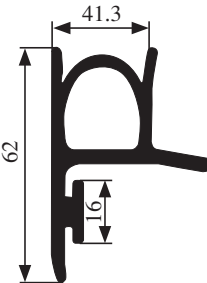
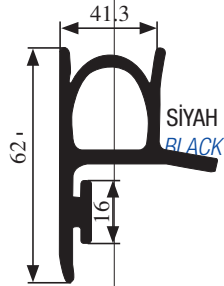

Teknik Resim Technical Drawing	Kod Reference	Eski Kodu Old Ref.	Renk Color	Malzeme Material	Ambalaj Packing (mt.)
	C1.206	-	SİYAH BLACK	EPDM	100
	C1.207	-	SİYAH BLACK	EPDM	100
	C1.208	-	SİYAH BLACK	EPDM	100
	C1.209	-	SİYAH BLACK	EPDM	50
	C1.210	-	SİYAH BLACK	EPDM	50
	C1.211		SİYAH BLACK	EPDM	5

scale:1/2

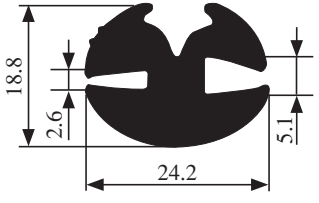
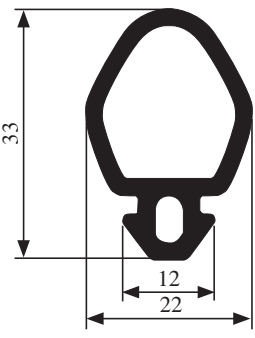
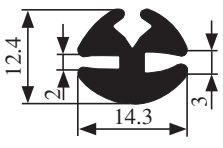
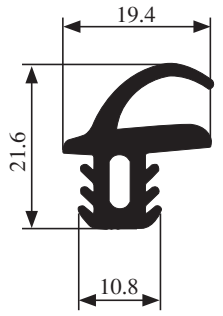
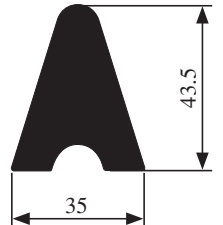
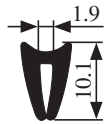
CAM LASTİKLERİ GLAZING PROFILES

Teknik Resim Technical Drawing	Kod Reference	Eski Kodu Old Ref.	Renk Color	Malzeme Material	Ambalaj Packing (mt.)
	C1.212	-	SİYAH BLACK	EPDM	50
	C1.213	-	SİYAH BLACK	EPDM	50
	C1.214	-	SİYAH BLACK	EPDM	50
	C1.216	-	SİYAH BLACK	EPDM	50
	C1.217	-	SİYAH BLACK	EPDM	50
	C1.218	-	SİYAH BLACK	EPDM	50

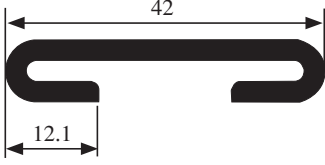
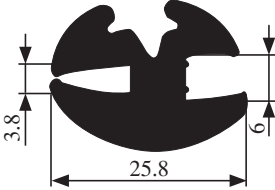
CAM LASTİKLERİ GLAZING PROFILES

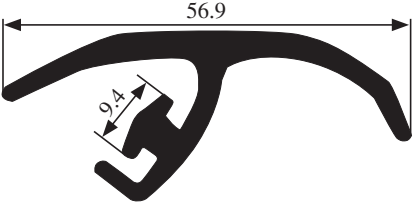
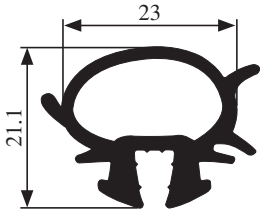
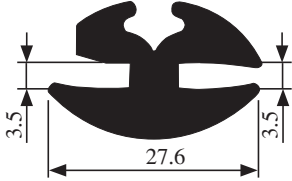
Teknik Resim Technical Drawing	Kod Reference	Eski Kodu Old Ref.	Renk Color	Malzeme Material	Ambalaj Packing (mt.)
	C1.219	-	SİYAH BLACK	EPDM	50
	C1.220	-	SİYAH BLACK	EPDM	50
	C1.221	-	SİYAH BLACK	EPDM	50
	C1.224	-	SİYAH BLACK	EPDM	50
	C1.225	-	SİYAH BLACK	EPDM	50
	C1.226	-	SİYAH BLACK	EPDM	50

CAM LASTİKLERİ GLAZING PROFILES

Teknik Resim Technical Drawing	Kod Reference	Eski Kodu Old Ref.	Renk Color	Malzeme Material	Ambalaj Packing (mt.)
	C1.227	-	SİYAH BLACK	EPDM	50
	C1.228	M223020600	SİYAH BLACK	EPDM	50
	C1.229	-	SİYAH BLACK	EPDM	100
	C1.230	-	SİYAH BLACK	EPDM	50
	C1.231	-	SİYAH BLACK	EPDM	15
	C1.232	-	SİYAH BLACK	EPDM	50

CAM LASTİKLERİ

Teknik Resim Technical Drawing	Kod Reference	Eski Kodu Old Ref.	Renk Color	Malzeme Material	Ambalaj Packing (mt.)
	C1.233	-	SİYAH BLACK	EPDM	50
	C1.234	-	SİYAH BLACK	EPDM	50
	C1.236	-	SİYAH BLACK	EPDM	50
	C1.237	-	SİYAH BLACK	EPDM	50
	C1.238	-	SİYAH BLACK	EPDM	50
	C1.239	-	SİYAH BLACK	EPDM	50



Tuzla Deri Organize San. Böl.
7. Yol F4 Parsel Tuzla / İstanbul

Tel. +90 216 394 07 02 (6 hat)
Fax. +90 216 394 07 09

www.tankaucuk.com.tr
info@tankaucuk.com.tr

CAM LASTİKLERİ
GLAZING PROFILES

Teknik Resim Technical Drawing	Kod Reference	Eski Kodu Old Ref.	Renk Color	Malzeme Material	Ambalaj Packing (mt.)
			SİYAH BLACK	EPDM	50
A B		C	SİYAH	EPDM	50

